



Seating Solutions

www.parinfurniture.com

Vision of PARIN

Core Purpose

To serve the world with a better lifestyle.

Core Values

1. Providing employment to people
2. Growth with ethics
3. Commitment to commitment
4. Constant Upgradation
5. Something for everybody
6. Valuing & nurturing relationships



BHAG (Big - Hairy - Audacious - Goal)

To be as respected & reputed as the Tata Group is today and become a 500Mn\$ diversified group by 2030.

Certifications



Parin Furniture proudly supports Make In India initiative



GOOD TOOLS ARE ESSENTIAL TO DO THE JOB WELL



Professional Quality, Parin Furniture has seen it's way.... Since its' inception, Parin pays attention to modernization process of Production equipment, through the continuous improvement of technology, now Parin has it's international first class computer numerical control furniture production centre and production lines, have modernization strength of Office Furniture, Workstation, Revolving Chairs and all kind of Wooden Panel Manufacturing. The advanced equipment and perfection process flow... It makes Parin Furniture lays a solid industry foundation.

PAN INDIA PRESENCE



More than **10 Million**
satisfied customers
across the nation

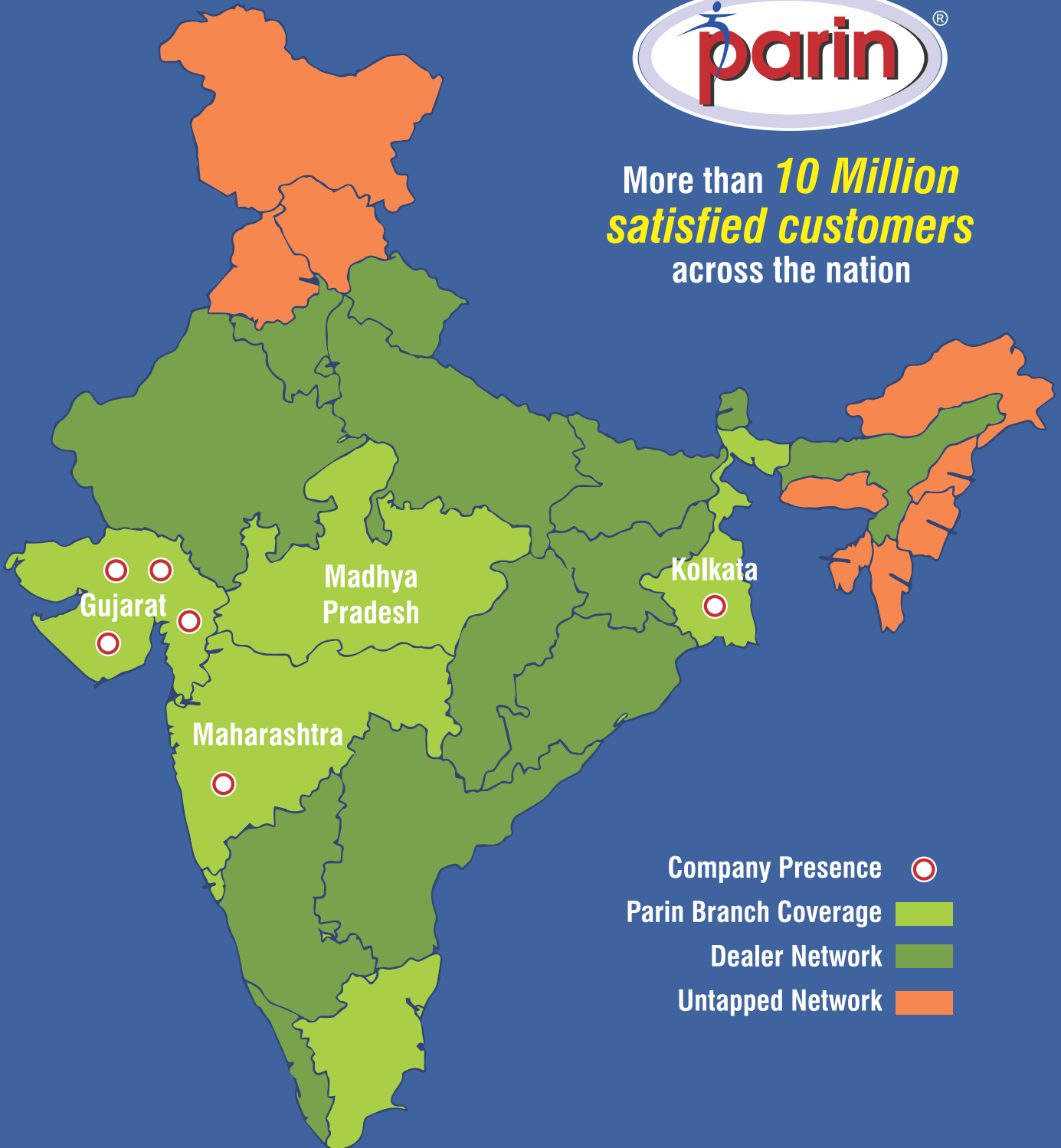

Company Presence

Parin Branch Coverage

Dealer Network

Untapped Network

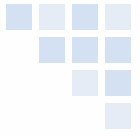

Brand Presence

Parin is a National brand having its presence in 18 states with a display area of 2,00,000sqft. & Warehouse of 1,25,000sqft. More than 900 Business Partners, Dealers and Distributors are connected to us which we consider as our biggest strength. We are committed to deliver world class quality products at Best Price over the years.



Our Strengths

Company's biggest strength is our Major products are Made in India with state-of-the-art manufacturing setup with modern machines & technology. We have our own Team of expert designers who design the product and we get it manufactured under our supervision. Quality for our products is being checked and verified by our Quality Inspector in various stages with zero tolerance for errors which is the core competency to ensure the continued good quality. We sustain brand values and product excellence.

Quality Assurance

Through active mentoring we create a culture where staff have the skills and are empowered to take responsibility for the results of their actions which contributes to the Quality of our products and success of the company... Through management review of our business management system we aim to continually improve Quality of processes, products and services... With our Core Values on constant up gradation, we periodically review our Quality Policy & Quality Standards... Company always emphasis on Quality with latest designs and excellent pre and post sales services to our business associates and valuable customer through which we have boosted our sales volume.



FROM THE DESK OF CMD

India is amongst the most thickly populated country's globally, with a large mass of floating population moving from one point to another thereby, creating a huge scope for managing in transit seating arrangements. Be it at a small dispensary, a hospital, a cinema house, a state run transport service, railway station or an airport, the need for public seating persists & grows as the movement from point to point increases.

Indian markets, have so far been dependant majorly on imported public seating systems to meet our customer needs which neither the purchaser nor the user have been satisfied with in quality and finishing standards.

"Parin" with it's in depth experience in the furniture industry has now come up with a complete basket of Public Seating Systems which it can cater to from a 1 Seater to a 5 seater lay out. The "Made In India" product will speak all basic parameters of elegance, comfortable seating, easy assembly but the top line feature will be product strength with longer life span.

With my more than 35 years of furniture industry exposure, I can confidently see "Parin" as a commendable brand with a product basket which will continue to match the expectation graph of our customer's across India and beyond.

Umesh Nandani



PLATINUM SERIES

01

PRIDE SERIES

07

PELICAN SERIES

13



PLATINUM

WAITING AREA CHAIRS

Available Options:

With Armrest: 1 Seating, 2 Seating, 3 Seating, 4 Seating & 5 Seating

Without Armrest: 2 Seating, 3 Seating, 4 Seating & 5 Seating

(Armrest Only at Both End of Chair)

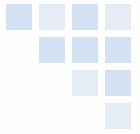

PLATINUM

WAITING AREA CHAIRS

Area of Utilization:

Public Waiting Areas like, Schools, Hospitals, Railway Stations, Airports, Passport Offices, etc.

| Seating | Overall Length | Overall Height | Floor to Seat Height | Depth of The Seat | Width of The Seat | Thickness of The Seat |
|-----------|----------------|----------------|----------------------|-------------------|-------------------|-----------------------|
| 1 Seating | 635 mm | 838 mm | 435 mm | 460 mm | 488 mm | 1.6 mm |
| 2 Seating | 1208 mm | 838 mm | 435 mm | 460 mm | 488 mm | 1.6 mm |
| 3 Seating | 1763 mm | 838 mm | 435 mm | 460 mm | 488 mm | 1.6 mm |
| 4 Seating | 2323 mm | 838 mm | 435 mm | 460 mm | 488 mm | 1.6 mm |
| 5 Seating | 2893 mm | 838 mm | 435 mm | 460 mm | 488 mm | 1.6 mm |

*All measurement in mm, and standard tolerance applicable in measurement.

Main Frame:

The Chair shall be on main frame Hexagonal Mild Steel of appropriate thickness and cross section so as to achieve the high durability as per the standard with powder coating.

Armrest & Legs:

The Armrest and Legs frame support shall be of high pressure aluminium die cast and finished with the powder coating. Armrest and Legs specially designed aesthetically to give the high level durability.

Seat & Back Rest:

The Seat & Back shall be made of heavy duty designer Mild Steel plates with insert of appropriate material and thickness to achieve high level durability and ergonomic seating comfort.

The product finishing, durability, stability and workmanship as of International Furniture Standards of BIFMA.

Available Colors:

Frame Structure: Gray & Silver – Matt & High Gloss Finish.

Seat & Backrest: Gray, Silver, Chrome, Red, Blue, etc.

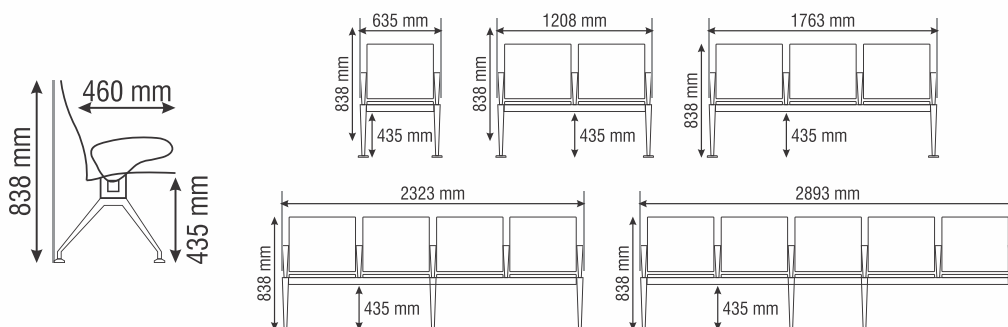



PLATINUM

WAITING AREA CHAIRS



Product No. **PLATINUM 5SA**
5 Seating (with Armrest)

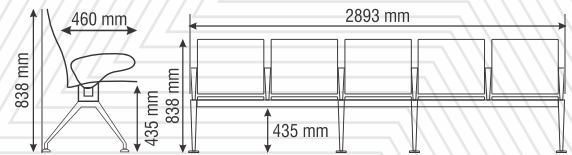

Product No. **PLATINUM 5S**
5 Seating (without Armrest)

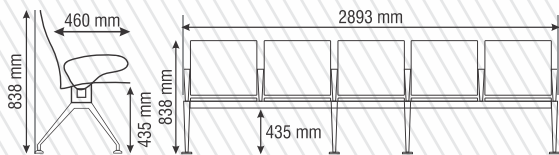

Available Colors

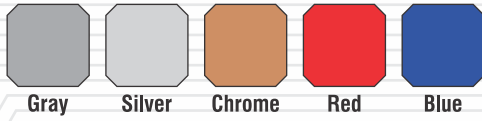

Product No. **PLATINUM 4SA**
4 Seating (with Armrest)

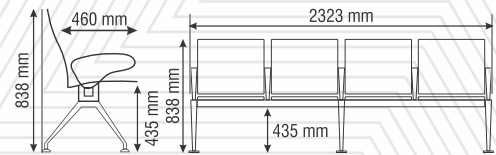

Product No. **PLATINUM 4S**
4 Seating (without Armrest)

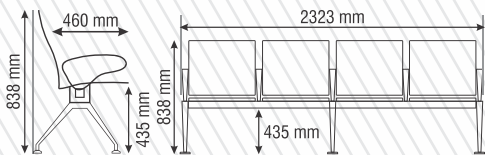

PLATINUM





PLATINUM

WAITING AREA CHAIRS



Product No. **PLATINUM 3SA**
3 Seating (with Armrest)

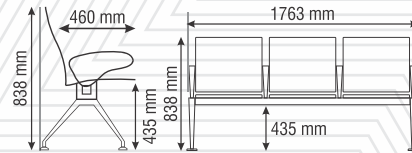

Product No. **PLATINUM 3S**
3 Seating (without Armrest)

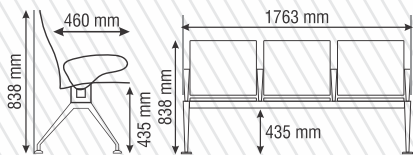



Product No. **PLATINUM 2SA**
2 Seating (with Armrest)

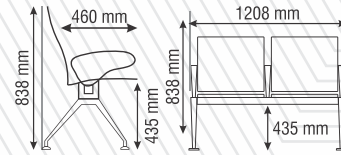

Product No. **PLATINUM 2S**
2 Seating (without Armrest)

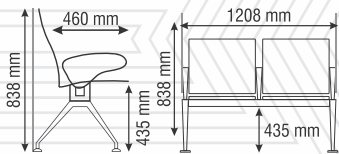

Product No. **PLATINUM 1SA**
1 Seating (with Armrest)

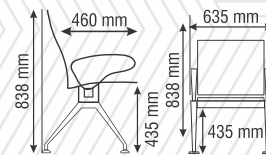

Available Colors

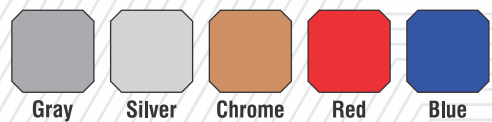

PLATINUM





PRIDE

WAITING AREA CHAIRS

Available Options:
With Armrest: 1 Seating, 2 Seating, 3 Seating, 4 Seating & 5 Seating
Without Armrest: 2 Seating, 3 Seating, 4 Seating & 5 Seating
(Armrest Only at Both End of Chair)

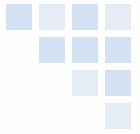

PRIDE

WAITING AREA CHAIRS

Area of Utilization:

Public Waiting Areas Like, Schools, Hospitals, Railway Stations, Airports, Passport Offices, etc.

| Seating | Overall Length | Overall Height | Floor to Seat Height | Depth of The Seat | Width of The Seat | Thickness of The Seat |
|-----------|----------------|----------------|----------------------|-------------------|-------------------|-----------------------|
| 1 Seating | 618 mm | 882 mm | 390 mm | 450 mm | 525 mm | 26 mm |
| 2 Seating | 1200 mm | 882 mm | 390 mm | 450 mm | 525 mm | 26 mm |
| 3 Seating | 1768 mm | 882 mm | 390 mm | 450 mm | 525 mm | 26 mm |
| 4 Seating | 2344 mm | 882 mm | 390 mm | 450 mm | 525 mm | 26 mm |
| 5 Seating | 2920 mm | 882 mm | 390 mm | 450 mm | 525 mm | 26 mm |

*All measurement in mm, and standard tolerance applicable in measurement.

Main Frame:

The Chair shall be on main frame Hexagonal Mild Steel of appropriate thickness and cross section so as to achieve the high durability as per the standard with powder coating.

Armrest & Legs:

The Armrest and Legs frame support shall be of high pressure aluminium die cast and finished with the powder coating. Base and Legs specially designed aesthetically to give the high level durability.

Seat & Back Rest:

The seat & back rest shall be made of high density self skinned integral PU foam reinforced with insert of appropriate material and thickness to achieve high level durability and ergonomic seating comfort.

The product finishing, durability, stability and workmanship as of International Furniture Standards of BIFMA.

Available Colors:

Frame Structure: Gray & Silver – Matt & High Gloss Finish.

Seat & Backrest: Black, Red and Blue.

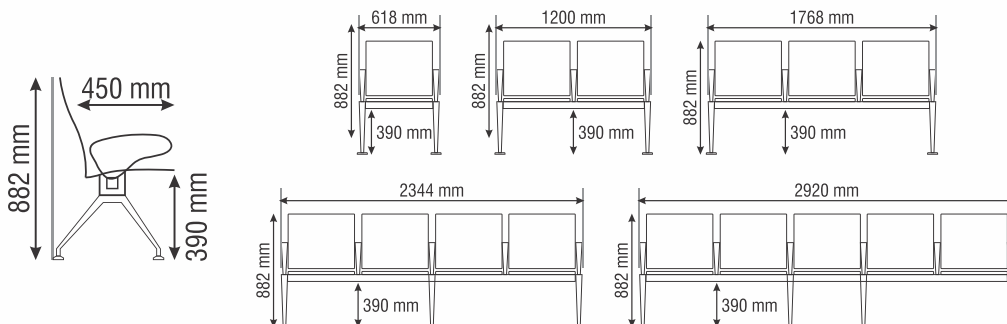



PRIDE

WAITING AREA CHAIRS



Product No. **PRIDE 5SA**
5 Seating (with Armrest)

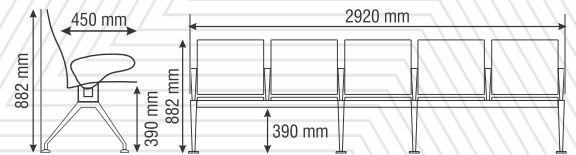

Product No. **PRIDE 5S**
5 Seating (without Armrest)

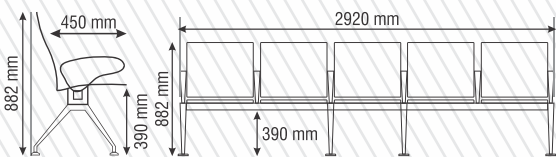

Available Colors



Black



Red



Blue



Product No. **PRIDE 4SA**
4 Seating (with Armrest)

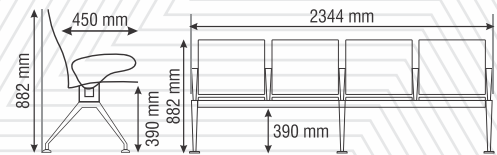

Product No. **PRIDE 4S**
4 Seating (without Armrest)

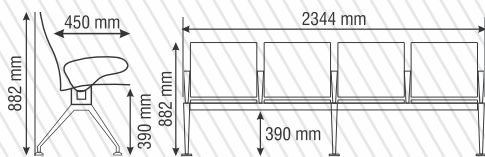

PRIDE





PRIDE

WAITING AREA CHAIRS



Product No. **PRIDE 3SA**
3 Seating (with Armrest)

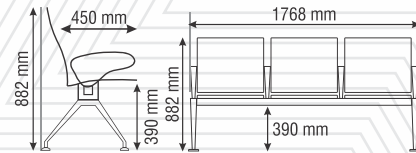

Product No. **PRIDE 3S**
3 Seating (without Armrest)

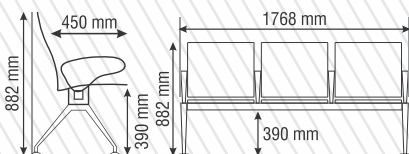



Product No. **PRIDE 2SA**
2 Seating (with Armrest)

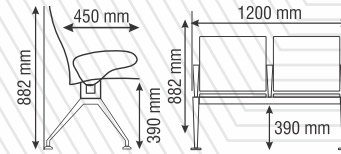

Product No. **PRIDE 2S**
2 Seating (without Armrest)

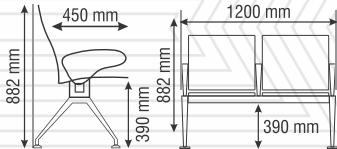

Product No. **PRIDE 1SA**
1 Seating (with Armrest)

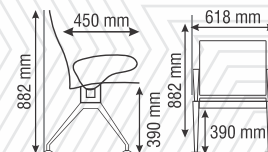

Available Colors



Black



Red



Blue

PRIDE





Image Need To Change



PELICAN

WAITING AREA CHAIRS

Available Options:
With Armrest: 1 Seating, 2 Seating, 3 Seating, 4 Seating & 5 Seating
Without Armrest: 2 Seating, 3 Seating, 4 Seating & 5 Seating
(Armrest Only at Both End of Chair)

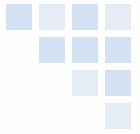

PELICAN

WAITING AREA CHAIRS

Area of Utilization:

Public Waiting Areas Like, Schools, Hospitals, Railway Stations, Airports, Passport Offices, etc.

| Seating | Overall Length | Overall Height | Floor to Seat Height | Depth of The Seat | Width of The Seat | Thickness of The Seat |
|-----------|----------------|----------------|----------------------|-------------------|-------------------|-----------------------|
| 1 Seating | 618 mm | 882 mm | 390 mm | 450 mm | 525 mm | 26 mm |
| 2 Seating | 1200 mm | 882 mm | 390 mm | 450 mm | 525 mm | 26 mm |
| 3 Seating | 1768 mm | 882 mm | 390 mm | 450 mm | 525 mm | 26 mm |
| 4 Seating | 2344 mm | 882 mm | 390 mm | 450 mm | 525 mm | 26 mm |
| 5 Seating | 2920 mm | 882 mm | 390 mm | 450 mm | 525 mm | 26 mm |

*All measurement in mm, and standard tolerance applicable in measurement.

Main Frame:

The Chair Beam shall be on Triangular CRCA of appropriate thickness and cross section so as to achieve the high durability as per the standard with powder coating.

Armrest & Legs:

The Armrest and Legs frame support shall be of CRCA and finished with the powder coating. Armrest and legs specially designed aesthetically to give the high level durability.

Seat & Back Rest:

The seat & back should be made of heavy duty perforated CRCA sheet with insert of appropriate material and thickness to achieve high level durability and ergonomic seating comfort.

The product finishing, durability, stability and workmanship as of International Furniture Standards of BIFMA.

Available Colors:

Frame Structure: Gray & Silver – Matt & High Gloss Finish.

Seat & Backrest: Gray, Silver, Chrome, Red, Blue, etc.

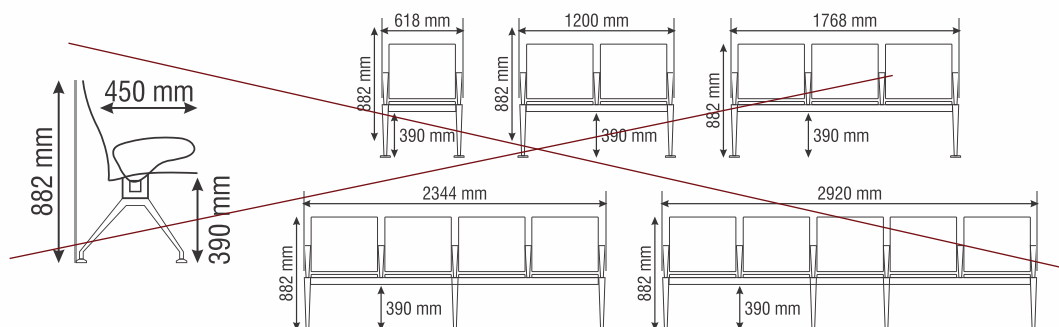



PELICAN

WAITING AREA CHAIRS



Product No. **PELICAN 5.0**
5 Seating (with Armrests)

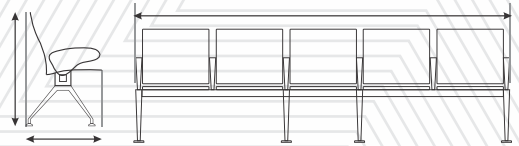

Product No. **PELICAN 5.1**
5 Seating (without Armrests)

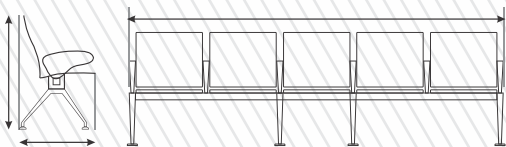

Available Colors



Black



Cherry



Blue



Product No. **PELICAN 4.0**
5 Seating (with Armrests)

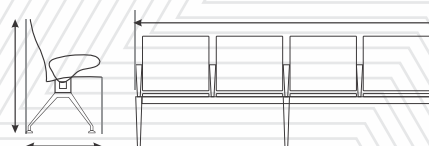

Product No. **PELICAN 4.1**
5 Seating (without Armrests)

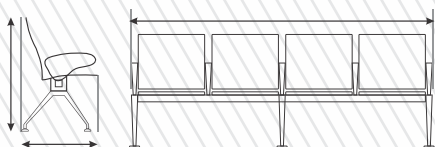

PELICAN





PELICAN

WAITING AREA CHAIRS



Product No. **PELICAN 3.0**
3 Seating (with Armrests)

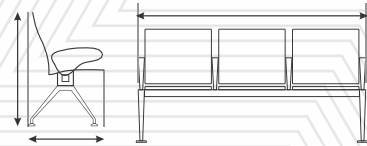

Product No. **PELICAN 3.1**
3 Seating (without Armrests)

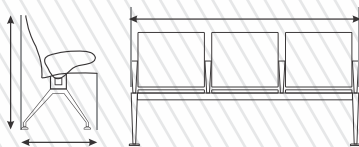



Product No. **PELICAN 2.0**
2 Seating (with Armrests)

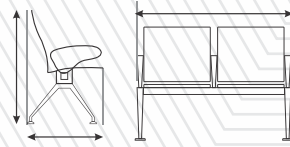

Product No. **PELICAN 2.1**
2 Seating (without Armrests)

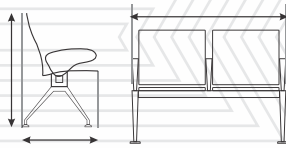

Product No. **PELICAN 1.0**
1 Seating (with Armrests)

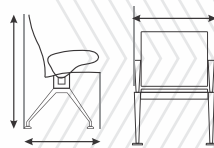

Available Colors



Black



Cherry



Blue

PELICAN



Matter of Pride

Parin Supplied Airport Waiting Chairs to accommodate passengers per day at 26 Airports of India. In the said rate contracts we served in following City Airports.

- Ahmedabad • Chennai • Kolkata • Pune • Goa • Lucknow • Raipur • Surat • Rajkot • Portblair
- Vizag • Thiruvananthpuram • Guwahati • Kanpur • Agra • Coimbtore • Maduari • Varanasi
- Imphal • Patna • Gaya • Bhubaneshwar • Jiasalmer • Udaipur • Amritsar • Kannur





Esteemed Clients

CORPORATES



GOVERNMENT & INSTITUTIONAL



HOTEL PROJECTS



E-TRADERS



RETAIL CHAIN





PARIN FURNITURE LIMITED

NH-8B, Gondal Road, Vavdi, Rajkot (Gujarat). Ph. : +91-281-3300777 | Helpline : +91-9898498984
E-mail : info@parinfurniture.com | Web. : www.parinfurniture.com