

LEADING BRAND OF INDIA
HEALTHCARE FURNITURE



PARIN FURNITURE LTD.

CORPORATE OFFICE & FACTORY ADDRESS :
PLOT # 1-3, SURVEY # 33, NATIONAL HIGHWAY 8B, VILLAGE - BILLAYALA,
TALUKA - GONDAL, DIST. RAJKOT, GUJARAT 360 311.

OUR GLOBAL NETWORK :
UK | DUBAI | UAE | BANGLADESH | SRILANKA | AFRICAN COUNTRIES

FOR SALES INQUIRY : +91 77977 00013 FOR CUSTOMER CARE - 98984 98984

INFO@PARINFURNITURE.COM | WWW.PARINFURNITURE.COM

HEALTHCARE FURNITURE



parin

LEADING BRAND OF INDIA
HEALTHCARE FURNITURE

www.parinfurniture.com

Since 1983



www.parinfurniture.com

www.parinfurniture.com

FOR WHOM
EVERY LIFE MATTERS...







GIFT YOURSELF WITH GOOD HEALTH AND GOOD SENSE.



CONTENTS

01	ICU Motorised Bed	12
02	ICU Semi-motorised Bed	20
03	ICU Manual Bed	26
04	Wardcare Solution	40
05	Attendent Bed	43
06	Transfer Solutions	45
07	Exam Room Solutions	50
08	Paedatric Bed	52
09	Accessories	53

A. Bed Side Locker
B. Trolleys
C. Overbed / Cardiac Table
D. Revolving Stool
E. Fix Stool

F. Saline Stand
G. Add Onn Accessories
H. Wheel Chairs
I . Mattress



parin

LEADING BRAND OF INDIA
HEALTHCARE FURNITURE

37+

MORE THAN 3 DECADES OF EXPERIENCE IN THE FURNITURE INDUSTRY.

27+

STRONG PRESENCE IN MORE THAN 27 STATES IN INDIA & EXPANDING GLOBALLY.

65+

OUR PRODUCTS ARE SAFE, EFFICIENT & EASY TO USE FOR MEDICAL SOLUTION.

350+

HIGHLY QUALIFIED & SKILLED WORKFORCE, EXPERT TEAM OF DESIGNERS & ENGINEERS.

2,50,000+

ONE OF THE LARGEST MANUFACTURING PLANT IN INDIA SPREADED IN MORE THAN 2.50.000 Sq.Ft. Area.

10,00,000+

WE HAVE DELIVERED MORE THAN 10,00,000 SKUs.

STRENGTH OF PARIN



Vision of **PARIN**

**TO SERVE THE WORLD WITH
A BETTER LIFESTYLE**

CORE VALUES

1. Providing employment to people
2. Growth with ethics
3. Commitment to Commitment
4. Constant Upgradation
5. Something for everybody
6. Valuing & nurturing relationship.

BHAG (BIG-HAIRY- AUDACIOUS-GOAL)

To be as respected & reputed as the Tata Group is today and become a 500Mn\$ Diversified Group by 2030.





About Technology

PARIN Furniture Limited, is India's one of the largest Healthcare Furniture manufacturer. Since its inception in 1983, Parin has worked in the Private and Government Sectors. The products are specially designed for patients to provide them with extracomfort, relief, and convenience during the time of hospitalization.

Our strong R&D capabilities put us in a superior position to introduce new and improved products, which are designed to meet and even exceed our customer's demands and expectations, into the market in the shortest time possible. We produce products with the highest commitment to quality at every stage from design to manufacturing.





INNOVATION OF PARIN



Design Innovation



PARIN healthcare Product Designers have always maintain close communication with medical service providers, to help them providing better solutions to their patients.

With a Rich & Steady experience in product structure and functional experience, PARIN continue to forge ahead with innovation and play a vitle role in as to improve the quality of care.

To serve the world with a better lifestyle.

**MORE THEN 10 MILLION
SATISFIED CUTOMER
IN PAN INDIA**

MADE IN INDIA 

Manufacturing Innovation



PARIN healthcare, One of the top brand in healthcare furniture always choose Authorized Suppliers Strictly to ensure the safety & reliability of raw material.

PARIN adopt robot welding, automatic epoxy coating, efficient assembly line, dedicated operators, rigorous quality control, only to gurantee PARIN's commitment on quality.

Service Innovation



PARIN healthcare have thorough service support Architecture - customer call centre for real time solution to clients, with advanced CRM system, spare Parts management, precautionary services, etc. No matter where customer is PARIN service will be always closed at hand.

Maintainance Innovation



PARIN healthcare have more then 50 engineers, and qualified service team that composed of professional & trained technitians and after sales staff.



International Organization
for Standardization



Certificate of
Compliance



Iso
13485 NABCB



US FDA



Energy
Management System



The National Small
Industries Corporation Ltd



“
Quality is not an act,
it is a habit.”





QUALITY OF PARIN



Detailed Vision

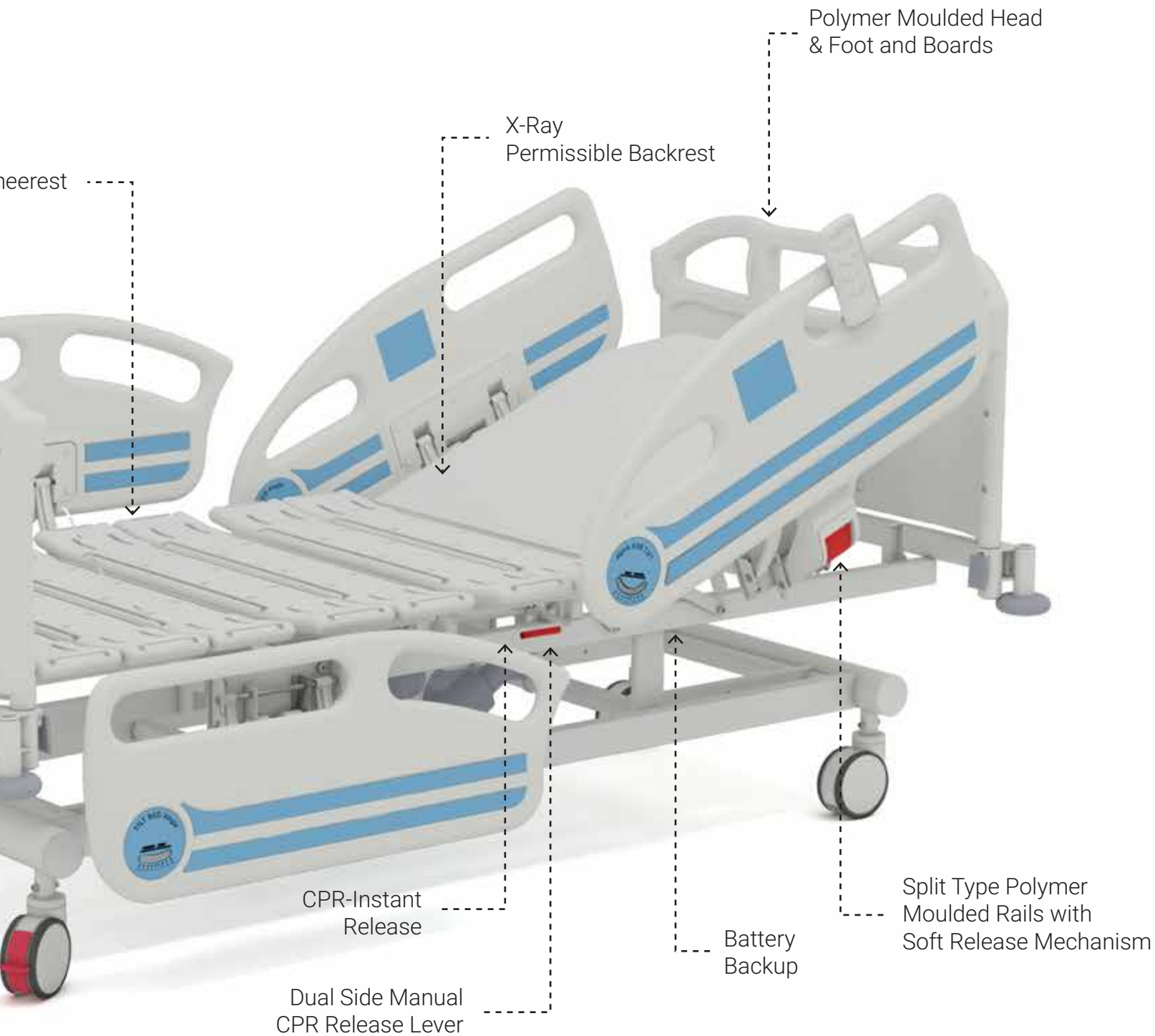

Bed Position

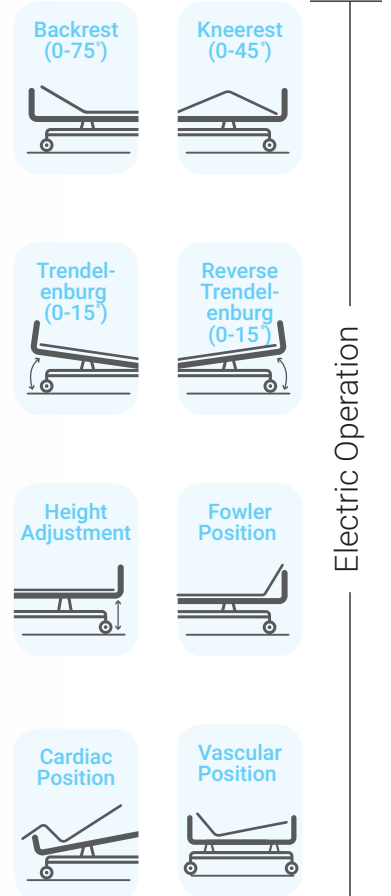

COLUMN BED

ADVANCED ICU COLUMN BED (FIVE FUNCTION)

Technical Specifications

External Dimension	2260L X 1075W (in mm)
Bed Frame	2165L X 1015W (in mm)
Matress Platform	1990L X 885W (in mm)
Minimum Height	500 mm
Maximum Height	900 mm
Backrest Angle	0-75* (+/- 5*)
Kneerest Angle	0-45* (+/- 5*)
Trendelenburg & Rev. Trendelenburg Angle	0 -15* (+/- 2*)
Safe Operating Load (Inc. Mattress & Accessories)	300 Kg
Patient Working Load	240 Kg

Technical Configuration

<input checked="" type="checkbox"/> Linear Motor	4 pcs
<input checked="" type="checkbox"/> Diagonal Lock Twin Wheel Caster (125 mm)	4 pcs
<input checked="" type="checkbox"/> Polymer Head & Foot Board	1 Set
<input checked="" type="checkbox"/> Polymer Side Rail	1 Set
<input checked="" type="checkbox"/> 100 mm Dia Wall Bumper Wheel	4 pcs
<input checked="" type="checkbox"/> Heavy Duty IV Pole	1 Set
<input checked="" type="checkbox"/> IV Pole Provision	4 pcs
<input checked="" type="checkbox"/> Urine Bag Holder	2 pcs
<input checked="" type="checkbox"/> Hand Remote Control : Single	1 pcs
<input checked="" type="checkbox"/> Mattress Platform with Polymer Top	1 set
<input checked="" type="checkbox"/> Mattress Arrestor	4 pcs
<input checked="" type="checkbox"/> Backrest with CPR Function	1 Set

Electrical Specification

Power Input	230 V AC 50 Hz Max 1 A
Power Output	24 V DC
Electrical Current Protection	Class 1, Type B
Liquid & Dust Protection	IP 54 - IP 66

Laminate Color Option :



Optional Accessories

Platform Accessories

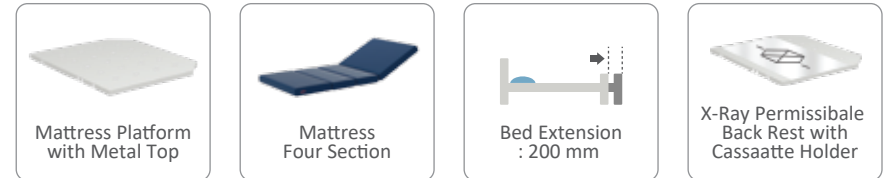

Electrical Accessories

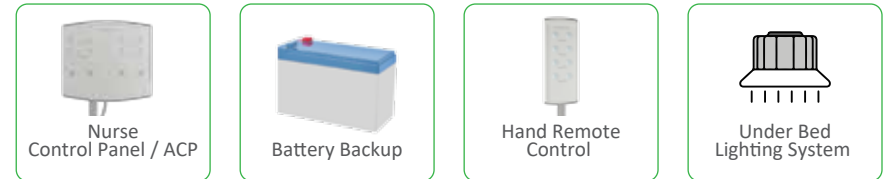

Addons Accessories

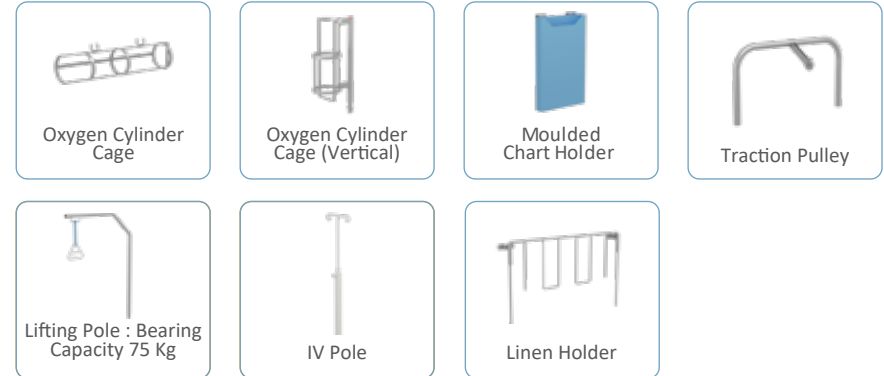

Castor Options

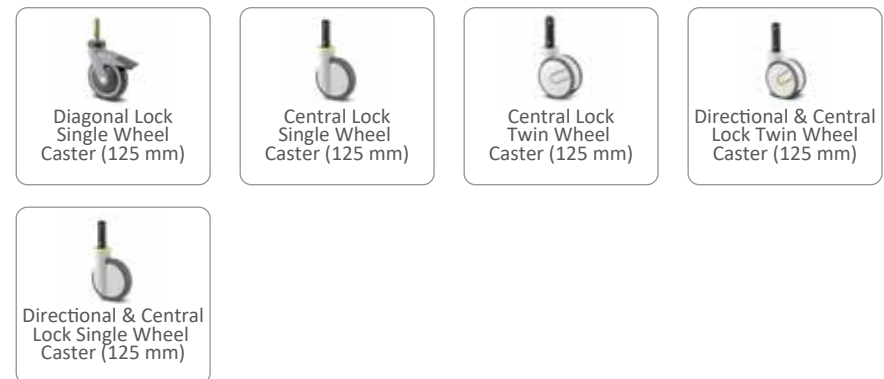

COLUMN BED

ADVANCED ICU COLUMN BED
(FIVE FUNCTION)



FM5F

FULLY MOTORISED ICU BED (FIVE FUNCTION)

Technical Specifications

External Dimension	2260L X 1075W (in mm)
Bed Frame	2165L X 1015W (in mm)
Matress Platform	1990L X 885W (in mm)
Minimum Height	450 mm
Maximum Height	850 mm
Backrest Angle	0-75* (+/- 5*)
Kneerest Angle	0-45* (+/- 5*)
Trendelenburg & Rev. Trendelenburg Angle	0 -15* (+/- 2*)
Safe operating Load (Inc. Mattress & Accessories)	250 Kg
Patient Working Load	190 Kg

Technical Configuration

<input checked="" type="checkbox"/> Linear Motor	4 pcs
<input checked="" type="checkbox"/> Diagonal Lock Twin Wheel Caster (125 mm)	4 pcs
<input checked="" type="checkbox"/> Polymer Head & Foot Board	1 Set
<input checked="" type="checkbox"/> Polymer Side Rail	1 Set
<input checked="" type="checkbox"/> 100 mm Dia Wall Bumper Wheel	4 pcs
<input checked="" type="checkbox"/> Heavy Duty IV Pole	1 Set
<input checked="" type="checkbox"/> IV Pole Provision	4 pcs
<input checked="" type="checkbox"/> Urine Bag Holder	2 pcs
<input checked="" type="checkbox"/> Hand Remote Control : Single	1 pcs
<input checked="" type="checkbox"/> Mattress Platform with Polymer Top	1 set
<input checked="" type="checkbox"/> Mattress Arrestor	4 pcs
<input checked="" type="checkbox"/> Backrest with CPR Function	1 Set

Electrical Specification

Power Input	230 V AC 50 Hz Max 1 A
Power Output	24 V DC
Electrical Current Protection	Class 1, Type B
Liquid & Dust Protection	IP 54 - IP 66

Color Option :

Sky Blue

Apple Green

Wood

Beige

Optional Accessories

Platform Accessories

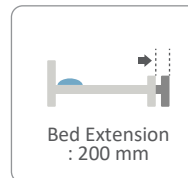

Electrical Accessories

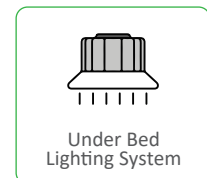
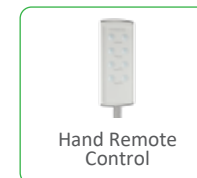
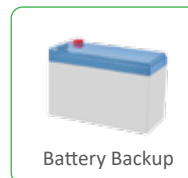
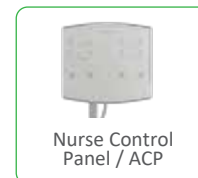

Addons Accessories

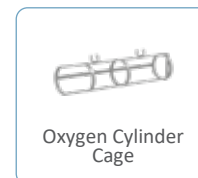
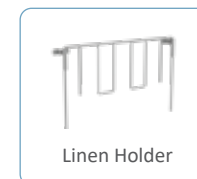
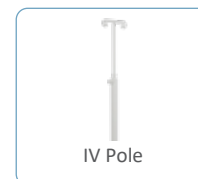



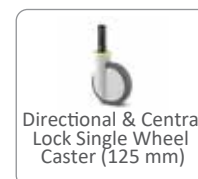
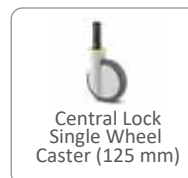





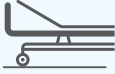

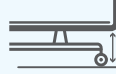
Castor Options



FM5F

**FULLY MOTORISED ICU BED
(FIVE FUNCTION)**

- Backrest**

- Kneerest**

- Height Adjustment**

- Trendelenburg**

- Reverse Trendelenburg**

- Cardiac Position**

- Fowler Position**

- Vascular Position**

- CPR-Instant Release**

- Angle Indicator**



FM5XR

FULLY MOTORISED ICU BED (FIVE FUNCTION) X-RAY VARIANT

Technical Specifications

External Dimension	2260L X 1075W (in mm)
Bed Frame	2165L X 1015W (in mm)
Matress Platform	1990L X 885W (in mm)
Minimum Height	450 mm
Maximum Height	850 mm
Backrest Angle	0-75* (+/- 5*)
Kneerest Angle	0-45* (+/- 5*)
Trendelenburg & Rev.Trendelenburg Angle	0 -15* (+/- 2*)
Safe Operating Load (Inc. Mattress & Accessories)	250 Kg
Patient Working Load	190 Kg

Technical Configuration

<input checked="" type="checkbox"/> Linear Motor	4 pcs
<input checked="" type="checkbox"/> Diagonal Lock Twin Wheel Caster (125 mm)	4 pcs
<input checked="" type="checkbox"/> Polymer Head & Foot Board	1 Set
<input checked="" type="checkbox"/> Polymer Side Rail	1 Set
<input checked="" type="checkbox"/> 100 mm Dia Wall Bumper Wheel	4 pcs
<input checked="" type="checkbox"/> Heavy Duty IV Pole	1 Set
<input checked="" type="checkbox"/> IV Pole Provision	4 pcs
<input checked="" type="checkbox"/> Urine Bag Holder	2 pcs
<input checked="" type="checkbox"/> Hand Remote Control : Single	1 pcs
<input checked="" type="checkbox"/> Mattress Platform with Polymer Top	1 set
<input checked="" type="checkbox"/> Mattress Arrestor	4 pcs
<input checked="" type="checkbox"/> Backrest with CPR Function	1 Set
<input checked="" type="checkbox"/> X-Ray Permissibile Back Rest with Cassaatte Holder	1 Set

Electrical Specification

Power Input	230 V AC 50 Hz Max 1 A
Power Output	24 V DC
Electrical Current Protection	Class 1, Type B
Liquid & Dust Protection	IF 54 - IP 66

Color Option :



Optional Accessories

Platform Accessories

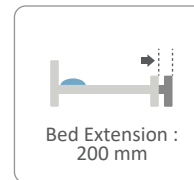

Electrical Accessories

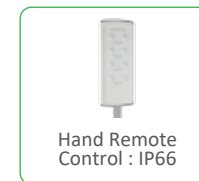
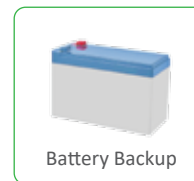
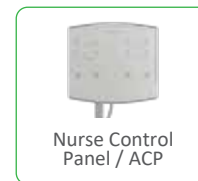

Addons Accessories

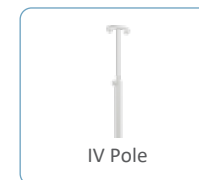
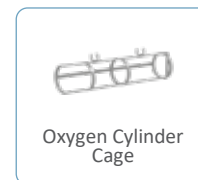
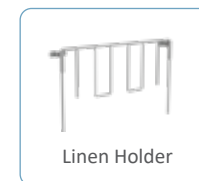

Castor Options

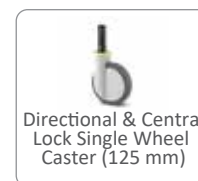

FM5XR

FULLY MOTORISED ICU BED
(FIVE FUNCTION) X-RAY VARIANT

Backrest

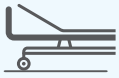

Kneerest

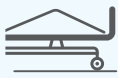

Height Adjustment

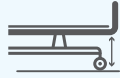

Trendelenburg



Reverse Trendelenburg

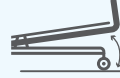

Cardiac Position



Fowler Position



Vascular Position



CPR-Instant Release



Angle Indicator



FM3F

FULLY MOTORISED ICU BED (THREE FUNCTION)

Technical Specifications

External Dimension	2260L X 1075W (in mm)
Bed Frame	2165L X 1015W (in mm)
Matress Platform	1990L X 885W (in mm)
Minimum Height	450 mm
Maximum Height	770 mm
Backrest Angle	0-75* (+/- 5*)
Kneerest Angle	0-45* (+/- 5*)
Safe Operating Load (Inc. Mattress & Accessories)	200 Kg
Patient Working Load	160 Kg

Technical Configuration

<input checked="" type="checkbox"/> Linear Motor	3 pcs
<input checked="" type="checkbox"/> Diagonal Lock Twin Wheel Caster (125 mm)	4 pcs
<input checked="" type="checkbox"/> Polymer Head & Foot Board	1 Set
<input checked="" type="checkbox"/> Polymer Side Rail	1 Set
<input checked="" type="checkbox"/> 100 mm Dia Wall Bumper Wheel	4 pcs
<input checked="" type="checkbox"/> IV Pole	1 Set
<input checked="" type="checkbox"/> IV Pole Provision	4 pcs
<input checked="" type="checkbox"/> Urine Bag Holder	2 pcs
<input checked="" type="checkbox"/> Hand Remote Control : Single	1 pcs
<input checked="" type="checkbox"/> Mattress Platform with Metal Top	1 set
<input checked="" type="checkbox"/> Mattress Arrestor	4 pcs

Electrical Specification

Power Input	230 V AC 50 Hz Max 1 A
Power Output	24 V DC
Electrical Current Protection	Class 1, Type B
Liquid & Dust Protection	IP 54 - IP 66

Color Option :



Optional Accessories

Platform Accessories

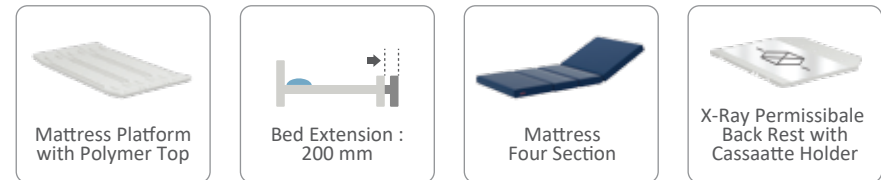

Electrical Accessories

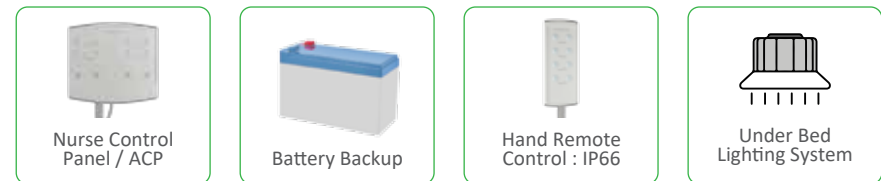

Addons Accessories

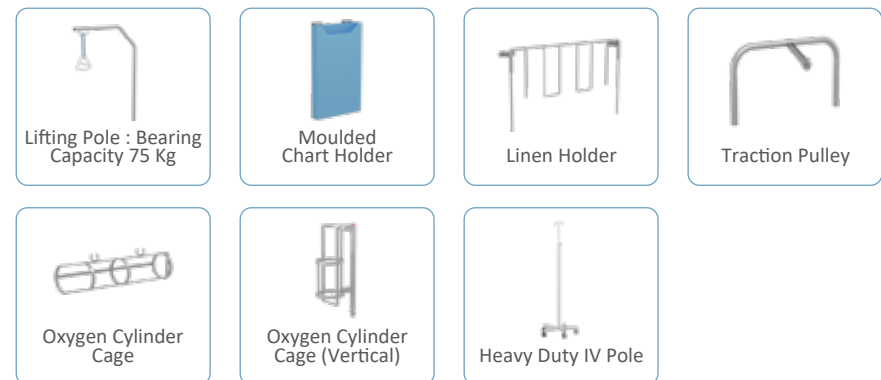

Castor Options

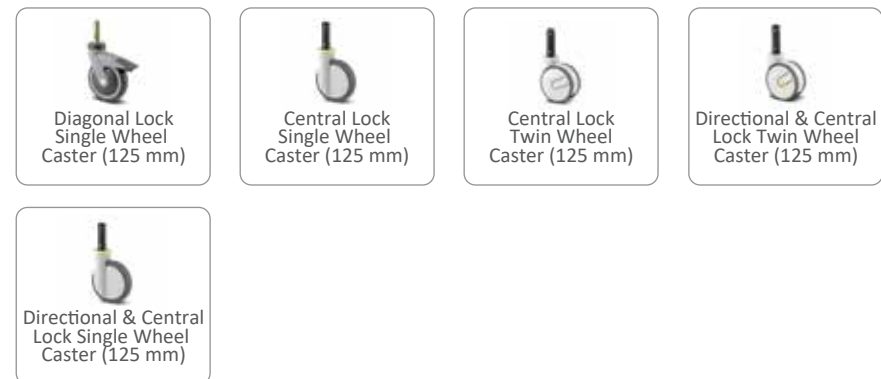

FM3F

**FULLY MOTORISED ICU BED
(THREE FUNCTION)**

Backrest

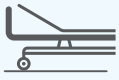

Kneerest



Height Adjustment

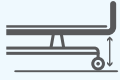

Vascular Position

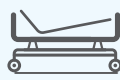

Fowler Position

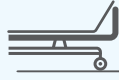

Angle Indicator



SM5F3M

SEMI MOTORISED ICU BED (FIVE FUNCTION)

Technical Specifications

External Dimension	2160L X 1100W (in mm)
Bed Frame	2085L X 1040W (in mm)
Matress Platform	1890L X 860W (in mm)
Minimum Height	520 mm
Maximum Height	780 mm
Backrest Angle	0-75* (+/- 5*)
Kneerest Angle	0-45* (+/- 5*)
Safe Operating Load (Inc. Mattress & Accessories)	150 Kg
Patient Working Load	125 Kg

Technical Configuration

<input checked="" type="checkbox"/> Linear Motor (Backrest, Kneerest & Height Adjustment)	3 pcs
<input checked="" type="checkbox"/> Manual Crank (Trendelenburg & Rev.Trendelenburg)	1 pcs
<input checked="" type="checkbox"/> Diagonal Lock Single Wheel Caster (125 mm)	4 pcs
<input checked="" type="checkbox"/> Polymer Head & Foot Board	1 Set
<input checked="" type="checkbox"/> Aluminium Alloy Foldable SS Side Rail (C Type)	1 Set
<input checked="" type="checkbox"/> 100 mm Dia Wall Bumper Wheel	4 pcs
<input checked="" type="checkbox"/> IV Pole	1 Set
<input checked="" type="checkbox"/> IV Pole Provision	4 pcs
<input checked="" type="checkbox"/> Urine Bag Holder	2 pcs
<input checked="" type="checkbox"/> Hand Remote Control : Single	1 pcs
<input checked="" type="checkbox"/> Mattress Platform with Metal Top	1 Set
<input checked="" type="checkbox"/> Mattress Arrestor	4 pcs
<input checked="" type="checkbox"/> Backrest with CPR Function	1 Set

Electrical Specification

Power Input	230 V AC 50 Hz Max 1 A
Power Output	24 V DC
Electrical Current Protection	Class 1, Type B
Liquid & Dust Protection	IP 54 - IP 66

Laminate Color Option :



Optional Accessories

Platform Accessories



Addons Accessories



Electrical Accessories

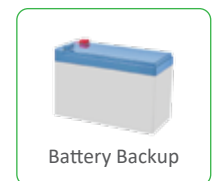
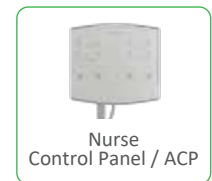

Head & Foot Board Options

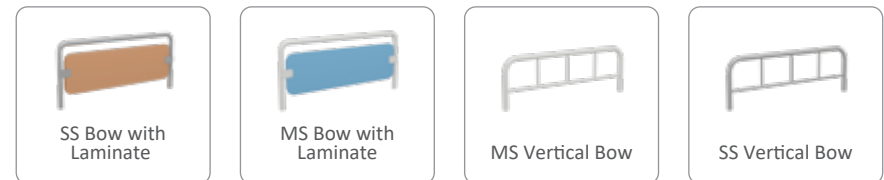

Side Rail Options

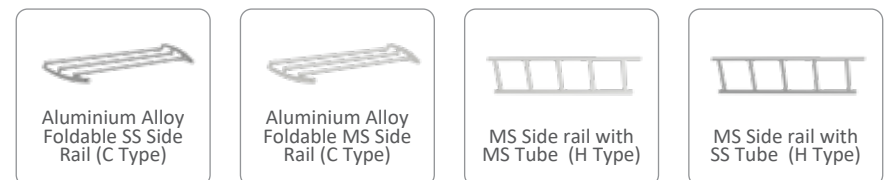

Castor Options



SM5F3M

**SEMI MOTORISED ICU BED
(FIVE FUNCTION)**



SM5F2M

SEMI MOTORISED ICU BED (FIVE FUNCTION)

Technical Specifications

External Dimension	2160L X 1100W (in mm)
Bed Frame	2085L X 1040W (in mm)
Matress Platform	1890L X 860W (in mm)
Minimum Height	520 mm
Maximum Height	780 mm
Backrest Angle	0-75* (+/- 5*)
Kneerest Angle	0-45* (+/- 5*)
Trendelenburg & Rev.Trendelenburg Angle	0 -12* (+/- 2*)
Safe Operating Load (Inc. Mattress & Accessories)	150 Kg
Patient Working Load	125 Kg

Technical Configuration

<input checked="" type="checkbox"/> Linear Motor (Backrest & Height Adjustment)	2 pcs
<input checked="" type="checkbox"/> Manual Crank (Kneerest, Trendelenburg & Rev. Trendelenburg)	2 pcs
<input checked="" type="checkbox"/> Diagonal Lock Single Wheel Caster (125 mm)	4 pcs
<input checked="" type="checkbox"/> Polymer Head & Foot Board	1 Set
<input checked="" type="checkbox"/> Aluminium Alloy Foldable SS Side Rail (C Type)	1 Set
<input checked="" type="checkbox"/> 100 mm Dia Wall Bumper Wheel	4 pcs
<input checked="" type="checkbox"/> IV Pole	1 Set
<input checked="" type="checkbox"/> IV Pole Provision	4 pcs
<input checked="" type="checkbox"/> Urine Bag Holder	2 pcs
<input checked="" type="checkbox"/> Hand Remote Control : Single	1 pcs
<input checked="" type="checkbox"/> Mattress Platform with Metal Top	1 set
<input checked="" type="checkbox"/> Mattress Arrestor	4 pcs

Electrical Specification

Power Input	230 V AC 50 Hz Max 1 A
Power Output	24 V DC
Electrical Current Protection	Class 1, Type B
Liquid & Dust Protection	IP 54 - IP 66

Laminate Color Option :



Optional Accessories

Platform Accessories



Addons Accessories

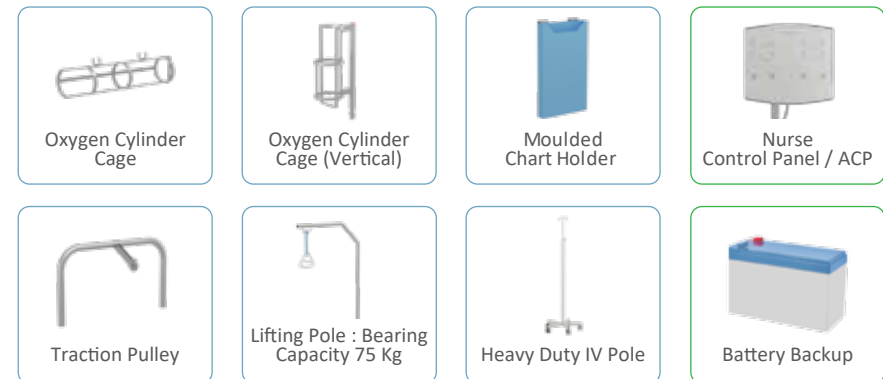

Electrical Accessories

Head & Foot Board Options



Side Rail Options

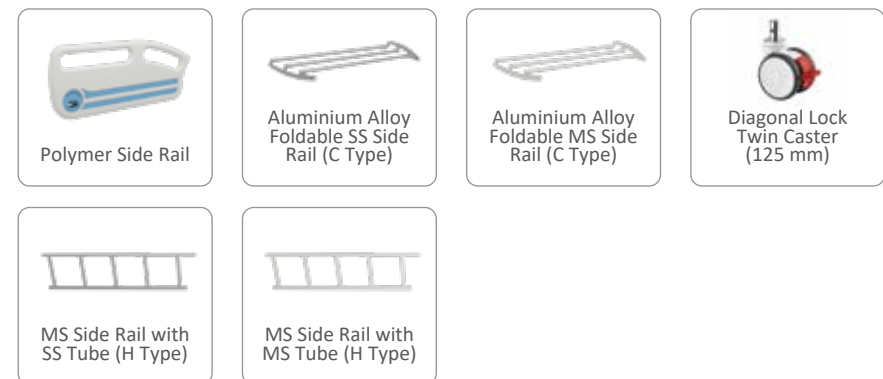

Castor Options

SM5F2M

SEMI MOTORISED ICU BED
(FIVE FUNCTION)



SM3F2M

SEMI MOTORISED ICU BED (THREE FUNCTION)

Technical Specifications

External Dimension	2160L X 1100W (in mm)
Bed Frame	2085L X 1040W (in mm)
Matress Platform	1890L X 860W (in mm)
Minimum Height	520 mm
Maximum Height	780 mm
Backrest Angle	0-75* (+/- 5*)
Kneerest Angle	0-45* (+/- 5*)
Safe Operating Load (Inc. Mattress & Accessories)	150 Kg
Patient Working Load	125 Kg

Technical Configuration

<input checked="" type="checkbox"/> Linear Motor (Backrest & Height Adjustment)	2 pcs
<input checked="" type="checkbox"/> Manual Crank (Kneerest)	1 pcs
<input checked="" type="checkbox"/> Diagonal Lock Single Wheel Caster (125 mm)	4 pcs
<input checked="" type="checkbox"/> Polymer Head & Foot Board	1 Set
<input checked="" type="checkbox"/> Aluminium Alloy Foldable SS Side Rail (C Type)	1 Set
<input checked="" type="checkbox"/> 100 mm Dia Wall Bumper Wheel	4 pcs
<input checked="" type="checkbox"/> IV Pole	1 Set
<input checked="" type="checkbox"/> IV Pole Provision	4 pcs
<input checked="" type="checkbox"/> Urine Bag Holder	2 pcs
<input checked="" type="checkbox"/> Hand Remote Control : Single	1 pcs
<input checked="" type="checkbox"/> Mattress Platform with Metal Top	1 set
<input checked="" type="checkbox"/> Mattress Arrestor	4 pcs

Electrical Specification

Power Input	230 V AC 50 Hz Max 1 A
Power Output	24 V DC
Electrical Current Protection	Class 1, Type B
Liquid & Dust Protection	IP 54 - IP 66

Laminate Color Option :



Optional Accessories

Platform Accessories



Addons Accessories

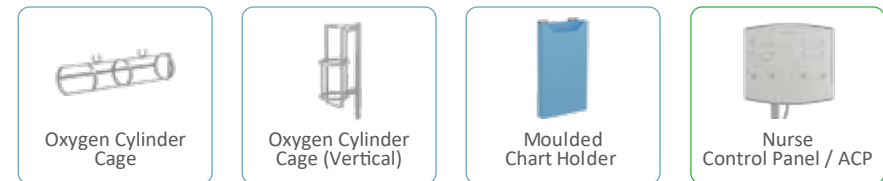

Electrical Accessories

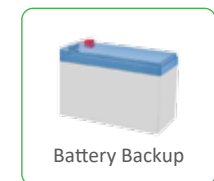
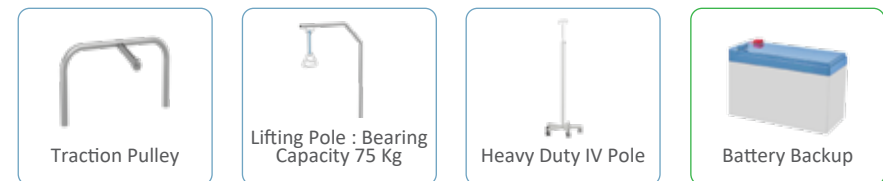
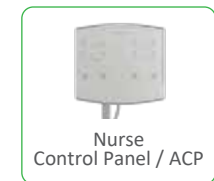

Head & Foot Board Options

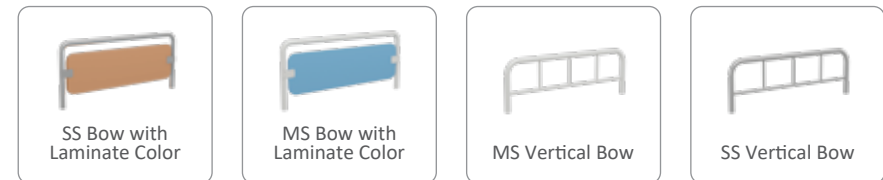

Side Rail Options



Castor Options



SM3F2M

**SEMI MOTORISED ICU BED
(THREE FUNCTION)**



IMB5F4S

ICU MANUAL BED 5 FUNCTION (WITH 4 CRANK)

Technical Specifications

External Dimension	2145L X 1100W (in mm)
Bed Frame	2085L X 1040W (in mm)
Matress Platform	1890L X 860W (in mm)
Minimum Height	520 mm
Maximum Height	780 mm
Backrest Angle	0-75* (+/- 5*)
Kneerest Angle	0-45* (+/- 5*)
Safe Operating Load (Inc. Mattress & Accessories)	150 Kg
Patient Working Load	125 Kg

Technical Configuration

<input checked="" type="checkbox"/> Linear Motion Crank Mechanism (Backrest, kneerest, Height & Tilt Trendelenburg & Rev.Trendelenburg)	4 Pcs
<input checked="" type="checkbox"/> Diagonal Lock Single Wheel Caster (125 mm)	4 pcs
<input checked="" type="checkbox"/> Polymer Head & Foot Board	1 Set
<input checked="" type="checkbox"/> Aluminium Alloy Foldable SS Side Rail (C Type)	1 Set
<input checked="" type="checkbox"/> 100 mm Dia Wall Bumper Wheel	4 pcs
<input checked="" type="checkbox"/> IV Pole	1 Set
<input checked="" type="checkbox"/> IV Pole Provision	4 pcs
<input checked="" type="checkbox"/> Urine Bag Holder	2 pcs
<input checked="" type="checkbox"/> Mattress Platform with Metal Top	1 set
<input checked="" type="checkbox"/> Mattress Arrestor	4 pcs

Laminate Color Option :



Optional Accessories

Platform Accessories



Addons Accessories

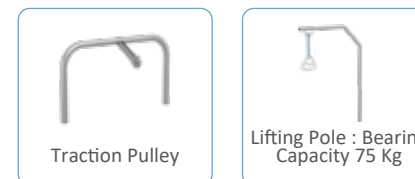

Head & Foot Board Options

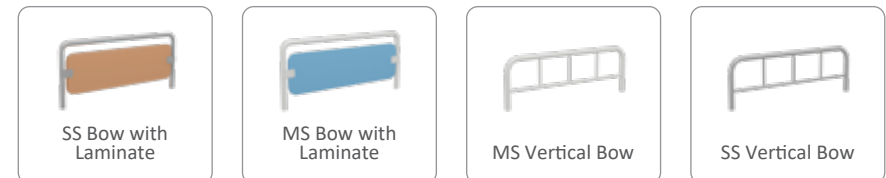

Side Rail Options



Castor Options



IMB5F4S

ICU MANUAL BED 5 FUNCTION
(WITH 4 CRANK)



IMB4F3SFH

ICU MANUAL BED WITH 4 FUNCTION (3 CRANK FIX HEIGHT)

Technical Specifications

External Dimension	2075L X 1000W (in mm)
Bed Frame	2015L X 945W (in mm)
Matress Platform	1870L X 825W (in mm)
Standard Height	600 mm
Backrest Angle	0-75* (+/- 5*)
Kneerest Angle	0-45* (+/- 5*)
Safe Operating Load (Inc. Mattress & Accessories)	150 Kg
Patient Working Load	125 Kg

Technical Configuration

<input checked="" type="checkbox"/> Linear Motion Crank Mechanism (Backrest, kneerest, Tilt Trendelenburg & Rev. Trendelenburg)	3 Pcs
<input checked="" type="checkbox"/> Diagonal Lock Single Wheel Caster (125 mm)	4 pcs
<input checked="" type="checkbox"/> Polymer Head & Foot Board	1 Set
<input checked="" type="checkbox"/> Aluminium Alloy Foldable SS Side Rail (H Type)	1 Set
<input checked="" type="checkbox"/> 100 mm Dia Wall Bumper Wheel	4 pcs
<input checked="" type="checkbox"/> IV Pole	1 Set
<input checked="" type="checkbox"/> IV Pole Provision	4 pcs
<input checked="" type="checkbox"/> Mattress Platform with Metal Top	1 set
<input checked="" type="checkbox"/> Mattress Arrestor	4 pcs

Laminate Color Option :



Optional Accessories

Platform Accessories



Addons Accessories

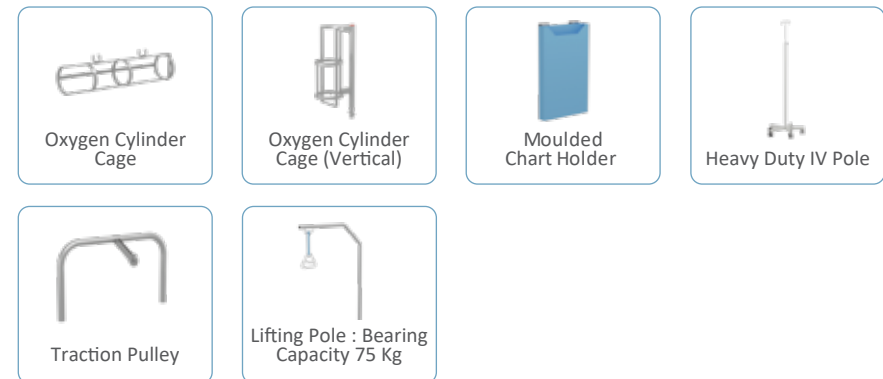

Head & Foot Board Options



Side Rail Options

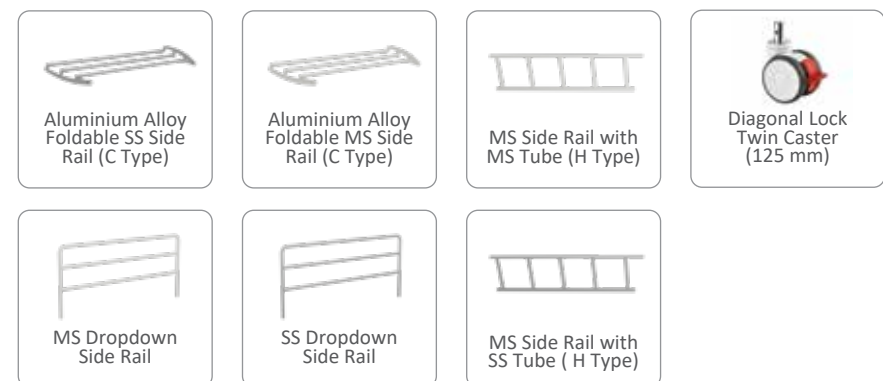

IMB4F3SFH

ICU MANUAL BED WITH 4 FUNCTION
WITH 3 CRANK (FIX HEIGHT)



IMB3F2SFH

ICU MANUAL BED WITH 3 FUNCTION (2 CRANK FIX HEIGHT)

Technical Specifications

External Dimension	2075L X 1000W (in mm)
Bed Frame	2015L X 945W (in mm)
Matress Platform	1870L X 825W (in mm)
Standard Height	600 mm
Backrest Angle	0-75* (+/- 5*)
Kneerest Angle	0-45* (+/- 5*)
Safe Operating Load (Inc. Mattress & Accessories)	150 Kg
Patient Working Load	125 Kg

Technical Configratation

<input checked="" type="checkbox"/> Linear Motion Crank Mechanism - Backrest & Tilt Trendelenburg & Rev. Trendelenburg	2 Pcs
<input checked="" type="checkbox"/> Diagonal Lock Single Wheel Caster (125 mm)	4 pcs
<input checked="" type="checkbox"/> Polymer Head & Foot Board	1 Set
<input checked="" type="checkbox"/> MS Dropdown Side Rail	1 Set
<input checked="" type="checkbox"/> 100 mm Dia Wall Bumper Wheel	4 pcs
<input checked="" type="checkbox"/> IV Pole	1 Set
<input checked="" type="checkbox"/> IV Pole Provision	4 pcs
<input checked="" type="checkbox"/> Mattress Platform with Metal Top	1 set
<input checked="" type="checkbox"/> Mattress Arrestor	4 pcs

Laminate Color Option :



Optional Accessories

Platform Accessories



Addons Accessories

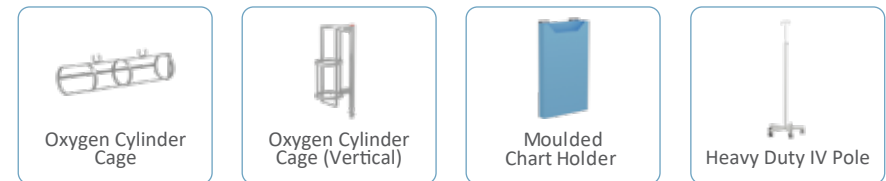

Head & Foot Board Options



Side Rail Options

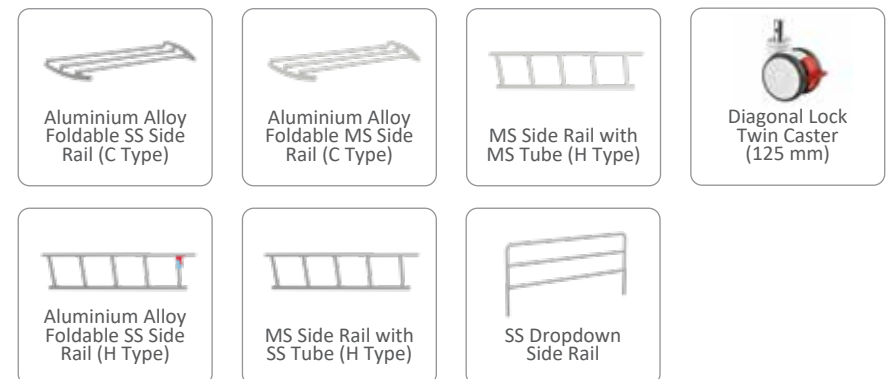

Castor Options

IMB3F2SFH

ICU MANUAL BED WITH 3 FUNCTION
(2 CRANK FIX HEIGHT)



H-FB2F2S60C

MANUAL FOWLER BED WITH 2 CRANK (FIX HEIGHT) WITH CASTOR

Technical Specifications

External Dimension	2075L X 1000W (in mm)
Bed Frame	2015L X 945W (in mm)
Mattress Platform	1870L X 825W (in mm)
Standard Height (with Castor)	600 mm
Backrest Angle	0-75* (+/- 5*)
Kneerest Angle	0-45* (+/- 5*)
Safe Operating Load (Inc. Mattress & Accessories)	150 Kg
Patient Working Load	125 Kg

Technical Configuration

<input checked="" type="checkbox"/> Linear Motion Crank Mechanism (Backrest & Kneerest)	2 Pcs
<input checked="" type="checkbox"/> Polymer Head & Foot Board	1 Set
<input checked="" type="checkbox"/> Aluminium Alloy Foldable SS Side Rail (C Type)	1 Set
<input checked="" type="checkbox"/> IV Pole Provision	4 pcs
<input checked="" type="checkbox"/> Mattress Platform with Metal Top	1 set
<input checked="" type="checkbox"/> Mattress Arrestor	4 pcs
<input checked="" type="checkbox"/> Diagonal Lock Single Caster (125 mm)	4 pcs

Optional Accessories

Platform Accessories



Addons Accessories

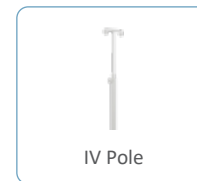

Head & Foot Board Options

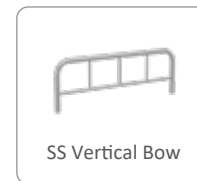

Side Rail Options

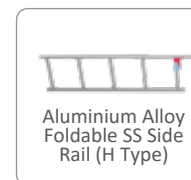
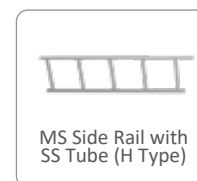
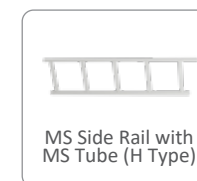

Laminate Color Option :

Sky Blue

Apple Green

Wood

Beige

H-FB2F2S60C

MANUAL FOWLER BED WITH 2 CRANK
(FIX HEIGHT) WITH CASTOR



H-FB2F2S60F

MANUAL FOWLER BED WITH 2 CRANK (FIX HEIGHT)

Technical Specifications

External Dimension	2075L X 1000W (in mm)
Bed Frame	2015L X 945W (in mm)
Mattress Platform	1870L X 825W (in mm)
Standard Height	600 mm
Backrest Angle	0-75* (+/- 5*)
Kneerest Angle	0-45* (+/- 5*)
Safe Operating Load (Inc. Mattress & Accessories)	150 Kg
Patient Working Load	125 Kg

Technical Configuration

<input checked="" type="checkbox"/> Linear Motion Crank Mechanism (Backrest & Kneerest)	2 Pcs
<input checked="" type="checkbox"/> SS Bow with Laminate for Head & Foot Board	1 Set
<input checked="" type="checkbox"/> Aluminium Alloy Foldable SS Side Rail (C Type)	1 Set
<input checked="" type="checkbox"/> IV Pole Provision	4 pcs
<input checked="" type="checkbox"/> Mattress Platform with Metal Top	1 set
<input checked="" type="checkbox"/> Mattress Arrestor	4 pcs

Optional Accessories

Platform Accessories



Addons Accessories

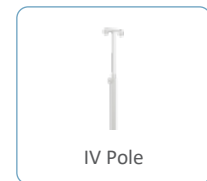

Head & Foot Board Options

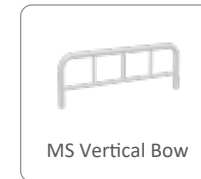

Side Rail Options

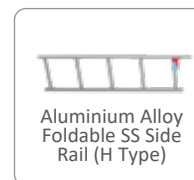
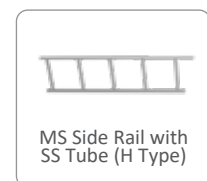
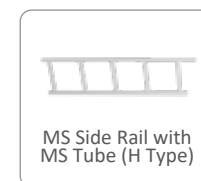

Laminate Color Option :

Sky Blue

Apple Green

Wood

Beige

H-FB2F2S60F

**MANUAL FOWLER BED WITH 2 CRANK
(FIX HEIGHT)**



H-SB1F1S60C

SEMI FLOWER BED WITH 1 CRANK
(FIX HEIGHT) WITH CASTOR

Technical Specifications

External Dimension	2075L X 1000W (in mm)
Bed Frame	2015L X 945W (in mm)
Matress Platform	1870L X 825W (in mm)
Standard Height	600 mm
Backrest Angle	0-75* (+/- 5*)
Safe Operating Load (Inc. Mattress & Accessories)	150 Kg
Patient Working Load	125 Kg

Technical Configuration

<input checked="" type="checkbox"/> Linear Motion Crank Mechanism (Backrest)	1 Pcs
<input checked="" type="checkbox"/> Polymer Head & Foot Board	1 Set
<input checked="" type="checkbox"/> Aluminium Alloy Foldable MS Side Rail (C Type)	1 Set
<input checked="" type="checkbox"/> IV Pole Provision	4 pcs
<input checked="" type="checkbox"/> Mattress Platform with Metal Top	1 set
<input checked="" type="checkbox"/> Mattress Arrestor	4 pcs
<input checked="" type="checkbox"/> 100 mm Dia Wall Bumper Wheel	4 pcs
<input checked="" type="checkbox"/> Diagonal Lock Single Wheel Caster (125 mm)	4 pcs

Optional Accessories

Platform Accessories



Addons Accessories

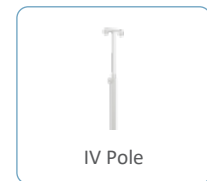

Head & Foot Board Options

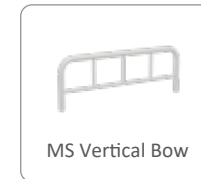

Side Rail Options

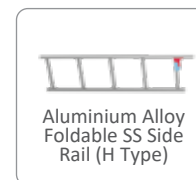
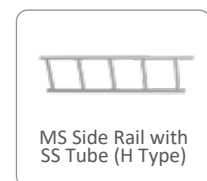
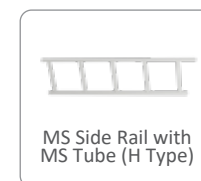

Laminate Color Option :

Sky Blue

Apple Green

Wood

Beige

H-SB1F1S60C

SEMI FOWLER BED WITH 1 CRANK
(FIX HEIGHT) WITH CASTOR



H-SB1F1S60F

SEMI FLOWER BED WITH 1 CRANK (FIX HEIGHT)

Technical Specifications

External Dimension	2075L X 1000W (in mm)
Bed Frame	2015L X 945W (in mm)
Matress Platform	1870L X 825W (in mm)
Standard Height	600 mm
Backrest Angle	0-75* (+/- 5*)
Safe Operating Load (Inc. Mattress & Accessories)	150 Kg
Patient Working Load	125 Kg

Technical Configuration

<input checked="" type="checkbox"/> Linear Motion Crank Mechanism (Backrest)	1 Pcs
<input checked="" type="checkbox"/> MS Bow with Laminate	1 Set
<input checked="" type="checkbox"/> Aluminium Alloy Foldable MS Side Rail (C Type)	1 Set
<input checked="" type="checkbox"/> IV Pole Provision	4 pcs
<input checked="" type="checkbox"/> Mattress Platform with Metal Top	1 set
<input checked="" type="checkbox"/> Mattress Arrestor	4 Pcs

Optional Accessories

Platform Accessories



Addons Accessories

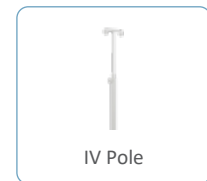

Head & Foot Board Options

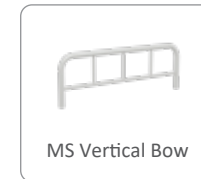

Side Rail Options

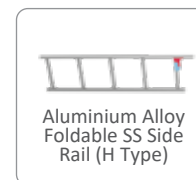
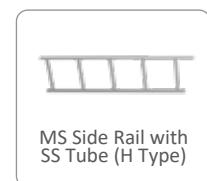
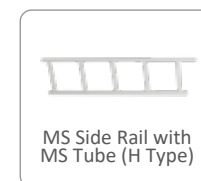

Laminate Color Option :

Sky Blue

Apple Green

Wood

Beige

H-SB1F1S60F

SEMI FOWLER BED WITH 1 CRANK
(FIX HEIGHT)



FB2F2S60F

FOWLER BED
(WITH TWO CRANK)



Technical Specifications

External Dimension	2075L X 1000W (in mm)
Bed Frame	2015L X 945W (in mm)
Matress Platform	1870L X 825W (in mm)
Standard Height	600 mm
Backrest Angle	0-75* (+/- 5*)
Kneerest Angle	0-45* (+/- 5*)
Safe Operating Load (Inc. Mattress & Accessories)	150 Kg
Patient Working Load	125 Kg

Technical Configration

<input checked="" type="checkbox"/> Linear Motion Crank Mechanism (Backrest & Kneerest)	2 Pcs
<input checked="" type="checkbox"/> MS Head & Foot Board	1 Set
<input checked="" type="checkbox"/> MS Dropdown Side Rail	1 Set
<input checked="" type="checkbox"/> IV Pole Provision	4 pcs
<input checked="" type="checkbox"/> Mattress Platform with Metal Top	1 set
<input checked="" type="checkbox"/> Mattress Arrestor	4 pcs

Optional Accessories

Platform Accessories

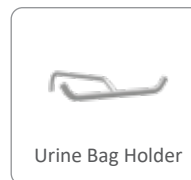

Addons Accessories

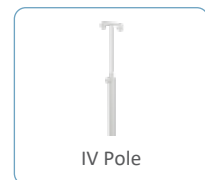

Side Rail Options

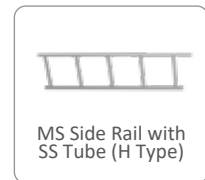
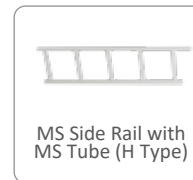

Head & Foot Board Options

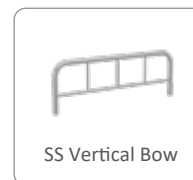
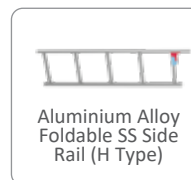

SB1F1S60F

SEMI FOWLER BED (WITH SINGLE CRANK)



Technical Specifications

External Dimension	2075L X 1000W (in mm)
Bed Frame	2015L X 945W (in mm)
Matress Platform	1870L X 825W (in mm)
Standard Height	600 mm
Backrest Angle	0-75* (+/- 5*)
Kneerest Angle	0-45* (+/- 5*)
Safe Operating Load (Inc. Mattress & Accessories)	150 Kg
Patient Working Load	125 Kg



Technical Configuration

<input checked="" type="checkbox"/> Linear Motion Crank Mechanism (Backrest)	1 Pcs
<input checked="" type="checkbox"/> MS Head & Foot Board	1 Set
<input checked="" type="checkbox"/> MS Dropdown Side Rail	1 Set
<input checked="" type="checkbox"/> IV Pole Provision	4 pcs
<input checked="" type="checkbox"/> Mattress Platform with Metal Top	1 set
<input checked="" type="checkbox"/> Mattress Arrestor	4 pcs

Optional Accessories

Platform Accessories

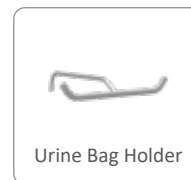

Addons Accessories

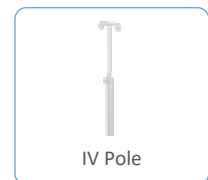

Side Rail Options

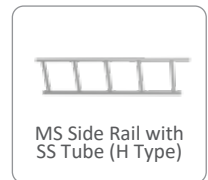
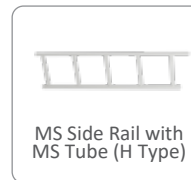

Head & Foot Board Options

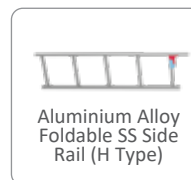

SB1S

SIMPLE BED (SINGLE SECTION)



Technical Specifications

External Dimension	2135L X 905W X 1090H (in mm)
Matress Platform	2035L X 900W (in mm)
Standard Height	600 mm
Safe Operating Load (Inc. Matress & Accessories)	150 Kg
Patient Working Load	125 Kg

Technical Configuration

<input checked="" type="checkbox"/> MS Vertical Bow for Head & Foot Board	1 Set
<input checked="" type="checkbox"/> Matress Platform with Metal Top	1 set
<input checked="" type="checkbox"/> Matress Arrestor	4 pcs

Laminate Color Option :

Sky Blue

Apple Green

Wood

Beige

Optional Accessories

Platform Accessories



Matress
Single Section



MS Bow with
Laminate



Urine Bag Holder

Addons Accessories

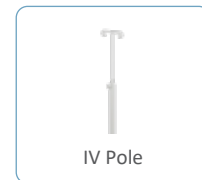

IV Pole



IV Pole Provision



Moulded
Chart Holder

Side Rail Options



MS Dropdown
Side Rail

ATTENDANT BED CUM CHAIR

AB-01



Technical Specifications

External Dimension	1900L X 660W (in mm)
Standard Height	450 mm
Safe Operating Load	150 Kg
(Inc. Mattress & Accessories)	125 Kg
Patient Working Load	



Technical Configuration

- MS Tubular Section Frame with Cushion

H-ATTENDENT BED

SIMPLE BED

AB-02



Technical Specifications

External Dimension	1980L X 910W (in mm)
Standard Height	400 mm
Safe Operating Load (Inc. Mattress & Accessories)	150 Kg
Patient Working Load	125 Kg

Technical Configuration

<input checked="" type="checkbox"/> MS Tubular Section Frame	
<input checked="" type="checkbox"/> Mattress Platform with Metal Top	1 Set
<input checked="" type="checkbox"/> Mattress Arrestor	

Optional Accessories

Optional Accessories



EMERGENCY & RECOVERY TROLLEY

TROLLEY



Technical Specifications

External Dimension	1910L X 710W (in mm)
Matress Platform	1790L X 555W (in mm)
Minimum Height	670 mm
Maximum Height	920mm
Strecher Dimension	1830L X 560W
Trendelenburg	0- 18*
Reverse Trendelenburg	0- 6*
Safe Operating Load (Inc. Mattress & Accessories)	150 Kg
Patient Working Load	125 Kg

Technical Configration

<input checked="" type="checkbox"/> Matress Platform with Compact Laminate, X Ray Permissiable Top with Cassatte Holder	1 Set
<input checked="" type="checkbox"/> Hydraulic Pump with Both Side Padel	1 Pcs
<input checked="" type="checkbox"/> Oxygen Cylinder Cage	1 Pcs
<input checked="" type="checkbox"/> Tray	
<input checked="" type="checkbox"/> 100 mm Dia Wall Bumper Wheel	4 Pcs
<input checked="" type="checkbox"/> Diagonal Lock Single Wheel Caster (125 mm)	1 Set
<input checked="" type="checkbox"/> SS Dropdown Side Rail	1 Set

Optional Accessories

Platform Accessories



Side Rail Options



STRECHER - TROLLEY (MS/SS)

STRECHER TROLLEY



Technical Specifications

External Dimension	1830L X 560W (in mm)
Matress Platform	1790L X 555W (in mm)
Standard Height	845 mm
Safe Operating Load (Inc. Mattress & Accessories)	150 Kg
Patient Working Load	125 Kg

Technical Configuration

- MS/SS Tubular Section Frame
- Stretcher top is MS/Aluminium Sheet

Optional Accessories

Platform Accessories



Stretcher Top with Aluminium Sheet



Stretcher Top with Stainless Steel Sheet



Single Section Mattress (25mm)

Side Rail Options



MS Dropdown Side Rail

Castor Options



Diagonal Lock Single Wheel Caster (150 mm)



Diagonal Lock Single Wheel Caster (200 mm)

FOLDING STRECHER TROLLEY

STRECHER TROLLEY



Technical Specifications

External Dimension	2100L X 640W (in mm)
Matress Platform	1850L X 560W (in mm)
Standard Height	830 mm
Foldable Length	1020L
Safe Operating Load (Inc. Mattress & Accessories)	150 Kg
Patient Working Load	125 Kg

Technical Configratation

- MS Tubular Section Frame
- Strecher Top is of Aluminium Sheet

Optional Accessories

Platform Accessories



Three Section
Mattress (25mm)

Side Rail Options



SS Dropdown
Side Rail

Castor Options



Diagonal Lock
Single Wheel
Caster (150 mm)



Diagonal Lock
Single Wheel
Caster (200 mm)

BIRTHING BED

Technical Specifications

External Dimension	1450L X 945W (in mm)
Matress Platform	1400L X 670W (in mm)
Minimum Height	680 mm
Maximum Height	800 mm
Backrest Angle	0-70* (+/- 5*)
Trendelenburg & Rev. Trendelenburg Angle	0 -08* (+/- 2*)
Safe operating Load (Inc. Mattress & Accessories)	150 Kg
Patient Working Load	125 Kg

Technical Configuration

<input checked="" type="checkbox"/> Linear Motor (Backrest, Height Adjustment & Trendelenburg & Rev. Trendelenburg)	3 pcs
<input checked="" type="checkbox"/> Diagonal Lock Twin Wheel Caster (125 mm)	4 pcs
<input checked="" type="checkbox"/> Polymer Head & Foot Board	1 Set
<input checked="" type="checkbox"/> Polymer Side Rail	1 Set
<input checked="" type="checkbox"/> 100 mm Dia Wall Bumper Wheel	4 pcs
<input checked="" type="checkbox"/> IV Pole Provision	2 pcs
<input checked="" type="checkbox"/> Urine Bag Holder	2 pcs
<input checked="" type="checkbox"/> Hand Remote Control : Single	1 pcs
<input checked="" type="checkbox"/> Mattress Platform with Laminated Top	1 set
<input checked="" type="checkbox"/> Mattress Arrestor	4 pcs

Electrical Specification

Power Input	230 V AC 50 Hz Max 1 A
Power Output	24 V DC
Electrical Current Protection	Class 1, Type B
Liquid & Dust Protection	IP 54 - IP 66

Laminate Color Option :

Sky Blue

Apple Green

Wood

Beige

Optional Accessories

Platform Accessories



Electrical Accessories

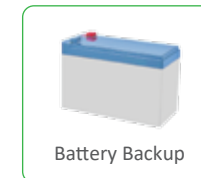

Addons Accessories



Side Rail Options



Castor Options

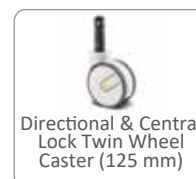
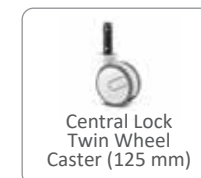

BIRTHING BED



GYNAEC COUCH



Technical Specifications

External Dimension	1960L X 580W (in mm)
Standard Height	750 (in mm)
Backrest with Gas Spring	0-45*
CRCA Tubular Section Frame with Mattress	
Safe Operating Load	230 Kg
Patient Working Load	180 Kg

EXAMINATION COUCH



Technical Specifications

External Dimension	1850L X 655W (in mm)
Standard Height	750 (in mm)
Backrest & Kneerest with Gas Spring	0-45*
CRCA Tubular Section Frame with Mattress	
Safe Operating Load	230 Kg
Patient Working Load	

EXAMINATION COUCH - WOODEN

Technical Specifications

External Dimension	1940L X 700W (in mm)
Standard Height	730 (in mm)
Backrest with Gas Spring	0- 45*
Safe Operating Load	230 kg
Patient Working Load	180 Kg



EXAMINATION TABLE

Technical Specifications

External Dimension	1900L X 550W (in mm)
Standard Height	750 (in mm)
CRCA Tubular Section Frame with Mattress	
Safe Operating Load	230 Kg
Patient Working Load	180 Kg



PEADIATRIC BED

(BABYBED)



Technical Specifications

External Dimension	1650L X 825W (in mm)
Standard Height	600 (in mm)
Mattress Platform	1550 L X 800 W
CRCA Tubular Section Frame	
Safe Operating Load	230 Kg
Patient Working Load	180 Kg

Optional Accessories

Platform Accessories



Single Section
Mattress (100 mm)

BED SIDE LOCKER

Accessories

*BSL-100
CRCA Sheet with MS/SS Top
(400L X 400W X 820H)*



*BSL-200
CRCA Sheet with SS Top
(400L X 400W X 820H)*



*BSL-300
CRCA Sheet with Membrane Top & Drawer
(400L X 400W X 820H)*



*BSL-400
CRCA Sheet with ABS Top & Drawer
(400L X 400W X 820H)*



*BSL-500
CRCA Sheet with Wooden Top
& Aluminium Strip
(525L X 500W X 805H)*



TROLLEYS

Accessories

**Crash Cart Trolley
ABS**
(960L X 500W X 1635H)



**Crash Cart Trolley
SS/MS**
(960L X 500W X 1635H)



**Jumbo
Oxygen Trolley**



Soiled Linen trolley
(510 DIA X 960H)



Instrument Trolley
(680L X 450W X 920H)
(1067L X 610W X 950H)
(914L X 508W X 900H)



Dressing Trolley
(1015L X 510W X 920H)



Medicine Trolley



OVER BED / CARDIAC TABLE

Accessories

Over bed Table

With Laminated Top
(1120L X 450W X 1070H)

Top Size
(760L X 450W)



Cardiac Table Manual

With Laminated/Membrane Top
(810L X 355W)



Cardiac Table Hydraulic

With Laminated/Membrane Top
(810L X 355W)



Mayos Table Tray

(560L X 400W 730-1300H)



STOOLS

Accessories

Revolving/ Fixed Stools

(Dia 365 mm top)

Height

Min - 550 - 760

Top Size - 305L X 305W X 510H

Min - 460 - 665

Base - 410L X 410W

RS02



RS03



RS04



RS01



RS05



FS01



FS02



SALINE STAND

Accessories

Saline Stand MS/SS

(1395 mm to 2290 mm) Height Adjustment

Option #1

Hook Provision : Two/Four

Option #2

Fixed Stand/with Castor



ADD ONNS

Accessories

Single Step Stool
(515L X 305W X 230H)



Double Step Stool
(605L X 510W X 450H)



Kick Bucket
(DIA 375 X 330H)



Single Tier Bowl Stand
(DIA 375 X 850H)



Two Tier Bowl Stand
(DIA 375 X 850H)



Bed Side Screen
(2440L X 1960H)



WHEEL CHAIR

Accessories

Wheel Chair
W01



Wheel Chair
W02



MATTRESS

Accessories

Single Section
Mattress



Two Section
Mattress



Four Section
Mattress



Air
Mattress



HEAD & FOOT BOARD

Accessories



Polymer head & Foot Board

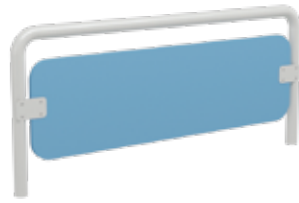

MS Bow with Laminate



MS Vertical Bow

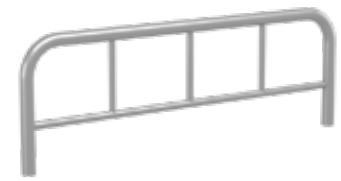

SS Vertical Bow



SS Bow with Laminate

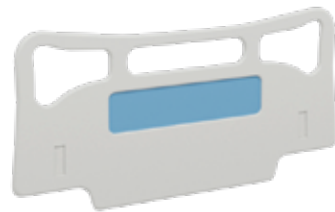

Polymer Head & Foot Board

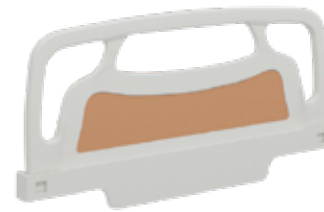

Polymer Head & Foot Board

SIDE RAIL

Accessories



Polymer Side Rail

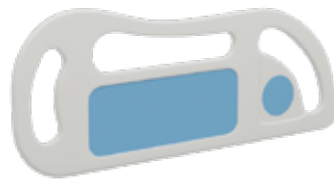

Polymer Side Rail



Aluminium Alloy Foldable SS Side Rail (C Type)



Aluminium Alloy Foldable MS Side Rail (C Type)



MS Side Rail with SS Tube (H Type)



MS Side Rail with MS Tube (H Type)



Aluminium Alloy Foldable SS Side Rail (H Type)



Aluminium Alloy Foldable MS Side Rail (H Type)



SS Dropdown Side Rail



MS Dropdown Side Rail

CASTORS

Accessories



Diagonal Lock
Single Wheel
Caster (125 mm)



Diagonal Lock
Twin Wheel
Caster (125 mm)



Directional & Central
Lock Single Wheel
Caster (125 mm)



Directional & Central
Lock Twin Wheel
Caster (125 mm)



Central Lock
Single Wheel
Caster (125 mm)



Central Lock
Twin Wheel
Caster (125 mm)

ELECTRICAL

Accessories



Nurse
Control Panel / ACP



Battery Backup



Hand Remote
Control

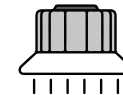

Under Bed
Lighting System

PLATFORMS

Accessories



Mattress Platform
with Polymer Top



Mattress Platform
with Metal Top



X-Ray Permissible
Backrest with
Cassette Holder



Backrest with
CPR Function



Bed Extension:
200 mm

ADD ONS

Accessories



Moulded
Chart Holder



Heavy Duty
IV Pole



IV Pole



Lifting Pole Bearing
Capacity 75 Kg



Cylinder Cage
Trolley



Oxygen Cylinder
Cage



Oxygen Cylinder
Cage (Vertical)



Linen Holder



Traction Pulley